

Dynamic analysis and design of a high voltage circuit breaker with spring operating mechanism

Wan-Suk Yoo¹, Seung-Oh Kim² and Jeong-Hyun Sohn^{3,*}

¹*School of Mechanical Engineering, Pusan National University, Jangjeon-dong, Geunjeung-gu, Busan, 609-735, Korea*

²*Digital Appliance Division, Samsung Electronics, Metan3-dong, Youngtong-gu, Suwon, 442-742, Korea*

³*School of Mechanical Engineering, Pukyong National University, Yongdang-dong, Nam-gu, Busan, 608-739, Korea*

(Manuscript Received April 10, 2007; Revised June 5, 2007; Accepted June 7, 2007)

Abstract

Spring Operating Mechanism (SOM) is a dynamic system to open and close the circuit breaker in a voltage controlling system. For a high-speed action of opening and closing within a few milli-seconds, a SOM consists of many links, joints, chains, and cams. Thus, various dynamic characteristics are occurred, especially large contact forces between the cam and the roller, the shaft and the stopper. To save time and money for a new design of SOM system, analysis of the mechanism is necessary. In this paper, a multibody dynamic analysis and test technique was applied for a SOM to predict, estimate and validate forces occurring during the operation. For the multibody dynamic analysis, the ADAMS program was employed for 145kV circuit breaker with a SOM. For an accurate modeling, several components were sequentially added and the reliability of modeling was validated through the comparison with test data of opening and closing.

Keywords: High voltage circuit breaker; Spring operating mechanism; ADAMS; High speed camera; Multibody dynamic analysis

1. Introduction

As the use of electricity is increasing, higher power transmission system, complex and large capacity of electric power machinery are required. Computer simulation like structural and dynamic analysis has been widely utilized in answering to customer's need for a complex system such as electric power machinery. A circuit breaker is installed in a electric power system to open and close the circuit repeatedly in scores of milliseconds. Since the operating force reaches scores of tons, it is essential to calculate contact forces and to review fatigue life for each moving link. For a advanced design of a high voltage circuit breaker with SOM(spring operating mechanism), it is required for the designer to estimate the accurate load history reacting on all the moving links and joints for various operating conditions. For this reason, a multi-

body dynamic analysis was necessary to estimate and validate dynamic response for calculating acceptable load history.

Ahn [1] showed an application of the lumped parameter spring model in the vacuum circuit breaker. Walser [2] modelled the high voltage switching gears by using ADAMS [3]. Martin et. al [4] analyzed the breaking velocity and stroke of a 145 kV circuit breaker by using the micro process measurement device. Toshine Takeuchi et. al [5] developed the dynamic analysis method of circuit breaker including the electric-magnetic force and applied the 245 kV circuit breaker.

In this paper, a multibody dynamic analysis was performed using the ADAMS program for a circuit breaker with SOM. And then, the reliability of dynamic analysis result was validated with test results through measurement with a high speed camera and sensors.

The dynamic modelling of a circuit breaker is ex-

*Corresponding author. Tel.: +82 51 620 1539, Fax.: +82 51 620 1405
E-mail address: jhsohn@pknu.ac.kr

plained in chapter 2, and the characteristics tests of the circuit breaker are shown in chapter 3. The simulation results are compared to tests in chapter 4 and the conclusions are in chapter 5.

2. Dynamic modeling of a circuit breaker

2.1 Circuit breaker with SOM

A circuit breaker shown in Fig. 1 consists of three modules, i.e., breakers, driving links system and SOM. A breaker consists of three pairs of a fixed contactor and moving parts that a current is sent and broken. As shown in Fig. 1, three rigid bars on top are fixed. A piston structure like a syringe under a fixed contactor is a moving link system, which consists of nozzle, arc contactor, puffer cylinder, and lever. Driving links system connects SOM with moving parts of breakers so that operating force of SOM is stably able to transfer to breakers and a current is sent and broken. A SOM is a multibody system that transmits the driving energy to joints, links and chains from metal coil springs that use compression energy on driving force for opening and closing of breakers.

In a SOM as shown in Fig. 1, there are four springs. Two of them are opening springs, and the other two springs are closing springs. For an open stage of the SOM, both springs are compressed as shown in Fig. 2(a). For the closing stage, the closing springs are released from compression as shown in Fig. 2(b). Two stages, opening stage and closing stage, are controlled by a cam system, the schematic diagram of which is shown in Fig.3. A cam shown in Fig.3 is operated by a driving motor and gears to compress open springs. In a closing motion, the closing latch works to rotate the cam and thus subsequently pushes out a roller with contact force, and finally makes links

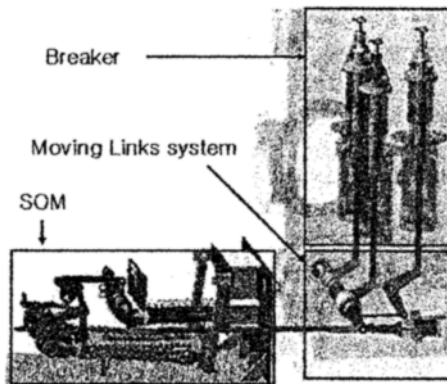

Fig. 1. Spring operating mechanism in a circuit breaker.

move. Because close springs are released during the closing motion, close springs are compressed again by driving motor and gears. Finally, electricity is to circulate.

In the next opening stage, when an over-voltage or over-current is transmitted at power transmission line or from transformer, compressed open springs are released by trip signal and operating force for opening breakers is transferred from SOM to driving links system with a moving link system. Finally, moving parts connected with fixed contactors get away in breakers so that a current is broken. While opening procedure is processing, opening velocity is decreased by a dashpot of driving links system like a damper and impact forces between links are mitigated to prevent parts from being broken.

Just a second after the opening is finished, compressed close springs are released by a closing signal such as description at above the initial stage so that open springs are compressed for the next opening motion. At this time, moving parts in breakers are returned back so that a current is sent again. Compressed opening springs works lastly when an over-voltage or over-current is transmitted again in a while.

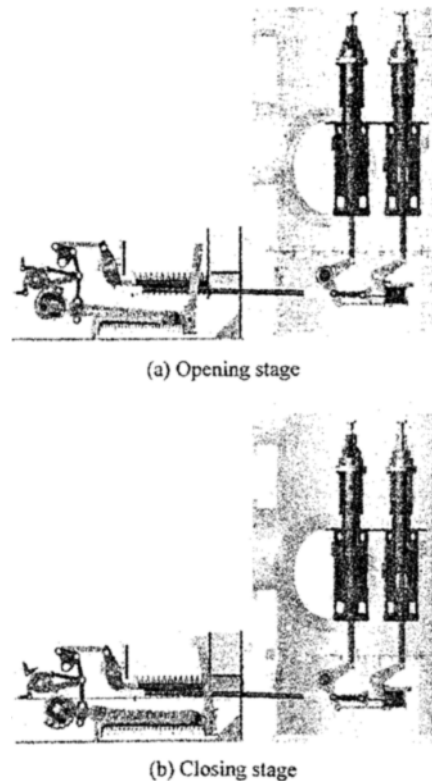

Fig. 2. Opening and closing stages of a circuit breaker.

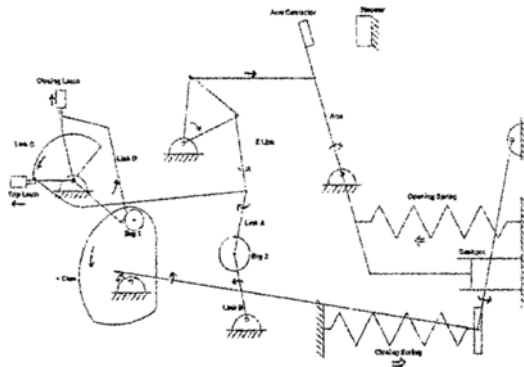

Fig. 3. Schematic diagram of a SOM.

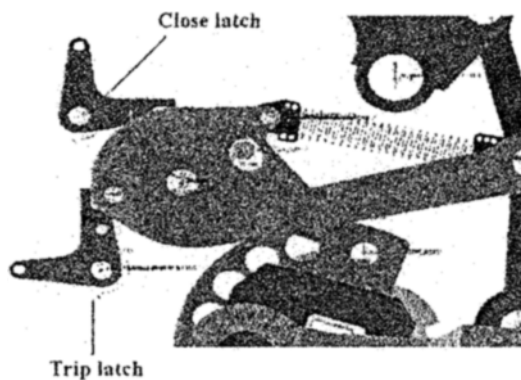

Fig. 4. Details around latches and a cam of SOM.

2.2 Multibody model of circuit breaker

In this research, a high voltage circuit breaker, especially 145kV class, was modelled for the initial stage and transformed to a parasolid model using the Solid Edge program. The ADAMS program was used for dynamic system modelling.

The two latches in the SOM, shown in Fig. 4, were included in modelling and step inputs were applied to generate revolute motions. The behaviour between end guides of opening and closing springs, as shown in Fig.5, was constrained with inline joints in the ADAMS program. A dashpot rod was modelled to a translational joint which constrained the motion along the axis of a dashpot cylinder. The measured reaction force of a dashpot was applied to the dashpot hinge as shown in Fig.6. Translational joints were chosen between fixed contactors and moving parts in breakers as shown in Fig. 7. For the modelling of forces in the puffer cylinder, the measured pressure in the puffer was applied. The measurement of pressure in a puffer was explained in chapter III.

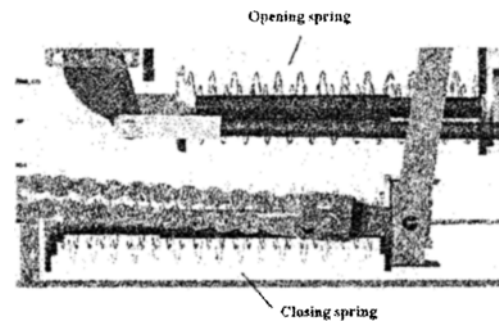

Fig. 5. Details around open and close springs of SOM.

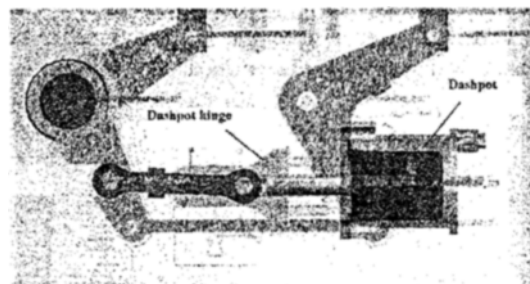

Fig. 6. Details around a dashpot of driving links system.

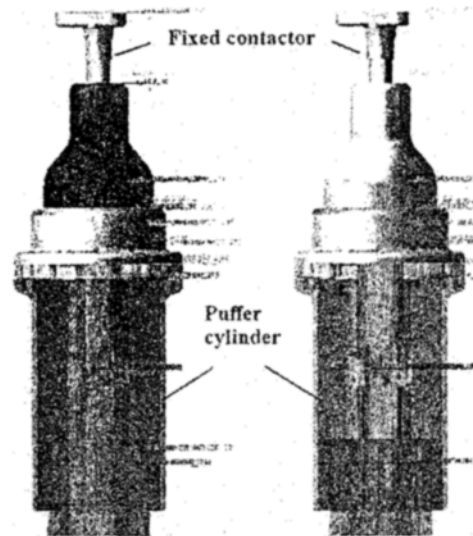

Fig. 7. Details around puffer cylinders of breakers.

The multibody model for the SOM system was modelled with many rigid bodies, various constraints and force elements such as contact and springs. In the system, 135 bodies were connected with 149 kinematic joints. Also 39 force elements in the ADAMS program were used to model forces. The system was simulated for 0.25 seconds with 250 time steps.

Throughout simulation results, moving distance of a puffer cylinder was compared with measured data and then opening velocity and closing velocity of a puffer cylinder were compared with test data. Moreover, dynamic analysis was carried out repeatedly to understand the influence of breakers' mass, pressure of a puffer and reaction force of a dashpot, respectively. In these analyses stage, contact parameter modelling was the most important and difficult because penetration depth between contacting parts had affected on moving distance. To find out the proper contact parameters, trial and error method was used in this model. Although we could guess that pressure of a puffer and reaction force of a dashpot seemed to be changing according to the position of a puffer cylinder and a dashpot rod during opening and closing stages, it was difficult to know the exact relation and tendency. Therefore, the data obtained from physical test was used, which is explained in the next chapter.

3. Characteristics tests of high voltage circuit breaker

3.1 Test setup

Test formation of high voltage circuit breaker is divided into seven entities such as a test product, sensors and measurement instruments as shown in Fig. 8. All sorts of sensors were connected with a multi-channel measurement device to measure the stroke, the reaction force of a dashpot, and the pressure of a puffer.

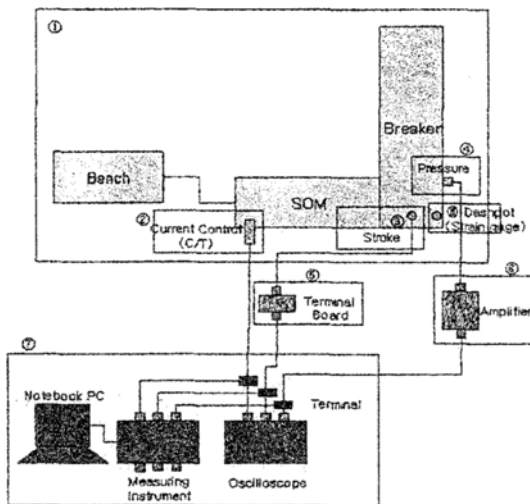

Fig. 8. Test schematic of high voltage circuit breaker.

3.2 Data measurement

3.2.1 Reaction force at a puffer

When opening and closing of breakers is occurred by the operation of a SOM, gas of the inside of a puffer cylinder blows out the electric arc between a fixed contactors and an arc contactor. Therefore, the inside pressure of a puffer cylinder is changed and this has an effect on the velocity of opening and closing. A pressure sensor was settled and the pressure on a puffer cylinder was measured. And then, the reaction force of a puffer, F_p was calculated by:

$$F_p = P_p A_p \tag{1}$$

where P_p is the measured inside pressure of a puffer cylinder with a sensor, A_p is the section area of the inside of a puffer cylinder as shown in Fig. 10 and subscript p means puffer. The pressure sensor for measuring dynamic pressures up to 1000 bar at temperatures up to 200°C was used. Fig. 9 shows the pressure sensor. The calculated forces were then applied in the ADAMS model.

Fig. 11 shows the calculated reaction force at a puffer. As shown in Fig. 10, the force at the opening section is bigger than that of the closing section. The maximum reaction force at a puffer was calculated about 4350N.

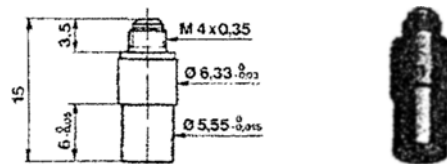

Fig. 9. Pressure sensor.

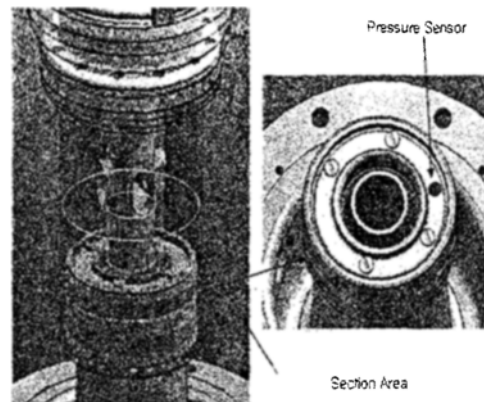

Fig. 10. Pressure measurement of a puffer.

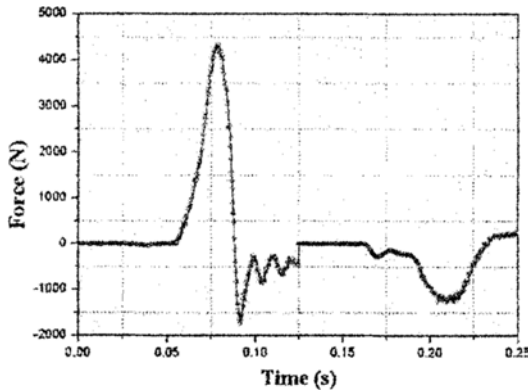

Fig. 11. Graph for reaction force at a puffer.

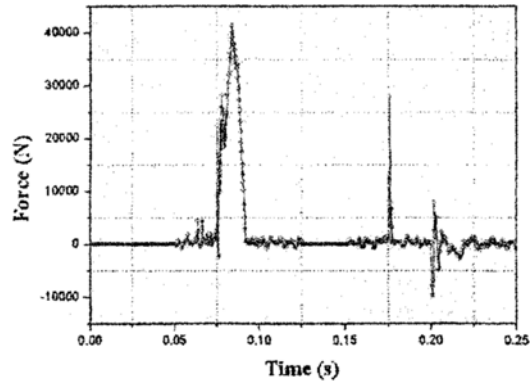

Fig. 13. Graph for reaction force at a dashpot.

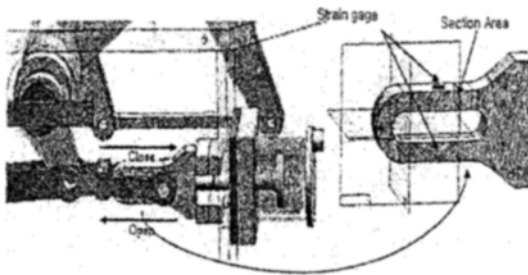

Fig. 12. Reaction force measurement at a dashpot.



Fig. 14. High speed camera used in this research.

3.2.2 Reaction force at a dashpot

Strain gages were attached to measure the reaction force at a dashpot as shown in Fig.12 [6]. Because a dashpot rod is interfered with another part during the motion, strain gages were attached on top and bottom of a dashpot hinge where is fixed. Also, it was not possible to attach and use a pressure sensor at a dashpot directly due lack of space. To apply for the ADAMS model, measured strain data, ϵ_h was converted into the dashpot reaction force, F_d by:

$$\sigma_h = E_h \epsilon_h \quad (2)$$

$$F_d = \sigma_h A_h \quad (3)$$

where σ_h is the stress in the position where a strain gage is attached, E_h is dashpot hinge's elastic modulus, A_h is the section area of a dashpot hinge and subscripts h and d mean hinge and dashpot, respectively. Fig. 13 shows the calculated the reaction force at a dashpot. The maximum reaction force at a dashpot was calculated about 41,320 N.

3.2.3 High speed camera shooting

Since the opening and closing of breakers of high voltage circuit breaker are completed in scores of milliseconds, the behaviour is unable to be confirmed visibly. Therefore, a high speed camera, Redlake's Motion Scope shown in Fig. 14, was used to capture the movements of parts and the flexible behaviour of links and springs of SOM. The results are analyzed and confirmed utilizing tracking software, Redlake Imaging Studio. The rotation motion of a link, in which a stroke sensor is installed, is compared with analysis result.

4. Comparison of simulation and experiment

4.1 Stroke comparison

The stroke means a translation distance of moving parts during opening and closing and then it is possible to measure it using the rotary sensor or the stroke sensor. The rotary sensor attached to the lever was used to know the translational displacement by measuring the rotating angle. The analysis result is the

same as the test result as shown in Fig. 15. As shown in Fig. 15, the test result and the analysis result are in a good agreement. The analysis result is smoother than the test result, which has some vibratory motion. The maximum velocity was appeared at the instant of 80% of the full stroke.

If the mass of a breaker was not included in the multibody model, the simulation results were quite different in opening velocity and closing velocity, as shown in Table 1. Thus, the mass of the breaker was included in the simulation model, and the results were much closer to the test results. The pressure of a puffer, and reaction force of a dashpot are applied sequentially, and analysis results for opening and closing velocity were compared with the test results as shown in Table 1. As shown in table 1, the analysis result is coincident accurately with the test result with puffer pressure and dashpot force in the simulation model. It is possible to understand the tendency that each force fact has effect on the open and close velocity from these analyses.

The puffer pressure affect during the open and the dashpot reaction force affect during the close. Therefore, to precisely predict the operating velocity in the simulation, the puffer and dashpot reaction force should be considered.

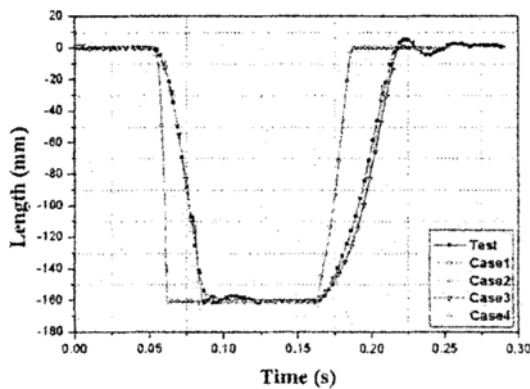

Fig. 15. Stroke comparison between analysis and test.

Table 1. Comparison with each modelling case.

Model Case	SOM	Breaker Mass	Puffer Pressure	Dashpot force	Open Vel.	Close Vel.
1	O	X	X	X	462%	200%
2	O	O	X	X	118%	109%
3	O	O	O	X	107%	103%
4	O	O	O	O	100%	100%

4.2 Movement of a lever

A lever shown in Fig.16 has a function to transfer an operating force from SOM to driving links system. To measure the link's behaviour, a target point was selected in the link, as shown in Fig. 16. The same position was chosen as the point of interest in the ADAMS simulation, which is shown in Fig. 17. As shown in Fig.18, vertical displacement and horizontal displacement of the lever are compared with test results. As shown in the Fig.18, dynamic analysis shows a good agreement to the physical test.



Fig. 16. Position for high speed camera measurement.



Fig. 17. Point of interest in computer simulation.

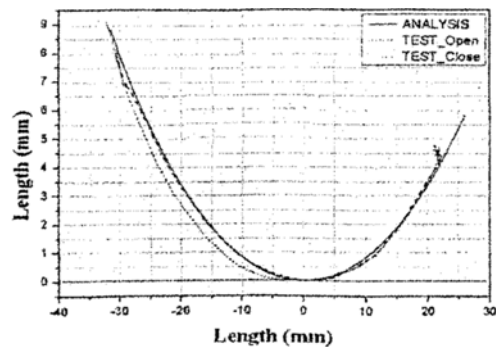

Fig. 18. Movement of a lever.

5. Conclusions

In this paper, dynamic modelling of a high voltage circuit breaker was performed and dynamic analysis was carried out to see the validity of the developed multibody model. From the comparison and validation with test results for opening and closing velocity, the following conclusions are obtained.

(1) For a precise modelling of the force in the puffer cylinder, pressure was measured and applied for the force element in the ADAMS model.

(2) To get more precise multibody model, sequential modelling including mass of the breaker, puffer pressure, and dashpot force was proposed. As a result, a multibody model with these force components gave better results, which are almost identical to the measured results.

(3) Since the reliability of the circuit breaker model had been proved in this simulation, physical experiments might be replaced to computer simulation for other types of circuit breakers. Thus, time and expenses for a new design of high voltage circuit breaker could be achieved.

(4) In this research, a dashpot model was made by test results. However, simulation results will be used to optimize the dashpot design in the future research.

(5) In addition, to get more accurate results, the detailed modelling of a puffer is required.

Acknowledgment

This work was supported by the Korea Research Foundation Grant funded by the Korean Government (MOEHRD) (KRF-2006-331-D00020).

References

- [1] K. Y. Ahn and S. H. Kim, Influence of spring dynamics and friction on dynamic responses in a spring-driven cam, *KSME A*. 27(2) (2003) 247-254.
- [2] H. Walser, Using ADAMS in the development of high voltage switching gears, 11th European ADAMS User's Conference (1996).
- [3] MSC Software, ADAMS(Automated Dynamic Analysis of Mechanical System) User Manual (2005).
- [4] Martin, H. B. de Grijp, Joost S. Bedet, Richard A. Hopkins and John E. Greyling, Condition monitoring of high voltage circuit breakers, *Institute of Electrical and Electronics Engineers*. 2 (1996) 880-885.
- [5] Toshie Takeuchi, Takafumi Nakagawa, Mitsuru Tsukima, Kenichi Koyama, Nobumoto Tohya and Tomotaka Yano, An electromagnetically actuated vacuum circuit breaker developed by electromagnetic analysis coupled with motion, *Institute of Electrical Engineers of Japan Transactions on Power and Energy*. 124(2) (2004) 321-326.
- [6] National Instruments Corp. Measuring Strain with Strain Gauges(Application Note 078), (2005) 5-6.